

ORDINANCE NO. 2016- 23

AN ORDINANCE OF THE CITY COUNCIL OF THE CITY OF NEW BRAUNFELS, TEXAS AMENDING THE "COTTON COTTAGES" PLANNED DEVELOPMENT DISTRICT DETAIL PLAN AND RELATED DEVELOPMENT STANDARDS; REPEALING ALL ORDINANCES IN CONFLICT; CONTAINING A SAVINGS CLAUSE; AND DECLARING AN EFFECTIVE DATE.

WHEREAS, the City Council of the City of New Braunfels has complied with all requirements of notice of public hearing as required by the Zoning Ordinance of the City of New Braunfels; and

WHEREAS, in keeping with the spirit and objectives of the "PD" Planned Development District, the City Council has given due consideration to all components of said district; and

WHEREAS, it is the intent of the City Council to provide harmony between existing zoning districts and proposed land uses; and

WHEREAS, the City Council desires to amend the "Cotton Cottages" Planned Development District Detail Plan and related Development Standards; **now, therefore,**

BE IT ORDAINED BY THE CITY COUNCIL OF THE CITY OF NEW BRAUNFELS, TEXAS:

SECTION 1

THAT the Detail Plan and related Development Standards adopted June 8, 2015, Ordinance Number 2015-34, is hereby replaced with the following described Amended Detail Plan and Amended Development Standards:

"Known as 5.732 acres out of Lot 2A-1, F & M Hanz Estate Resubdivision, Comal County, Texas, addressed at 1372 Hanz Drive, as delineated on Exhibit 'A' attached and adopting the Amended Detail Plan as Depicted on Exhibits 'B-1, B-2 and B-3' attached and the Amended Development Standards as stated in Exhibit 'C' attached."

SECTION 2

THAT all provisions of the Code of Ordinances of the City of New Braunfels not herein amended or repealed shall remain in full force and effect.

SECTION 3

THAT all other ordinances or parts of ordinances in conflict herewith are hereby repealed to the extent that they are in conflict.

SECTION 4

THAT if any provisions of this ordinance shall be held void or unconstitutional, it is hereby provided that all other parts of the same which are not held void or unconstitutional shall remain in full force and effect.

SECTION 5

THIS ordinance will take effect upon the second and final reading of same.

PASSED AND APPROVED: First Reading this the 25th day of April, 2016.

PASSED AND APPROVED: Second and Final Reading this the 9th day of May, 2016.

CITY OF NEW BRAUNFELS

BARRON CASTEEL, Mayor

ATTEST:

PATRICK D. ATEN, City Secretary

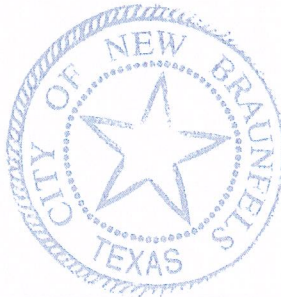

APPROVED AS TO FORM:

VALERIA M. ACEVEDO, City Attorney

LINE TABLE		
LINE	LENGTH	BEARING
L1	27.20'	S 52°19'35" W
L2	75.21'	S 74°48'31" W
L3	7.20'	N 35°43'46" W

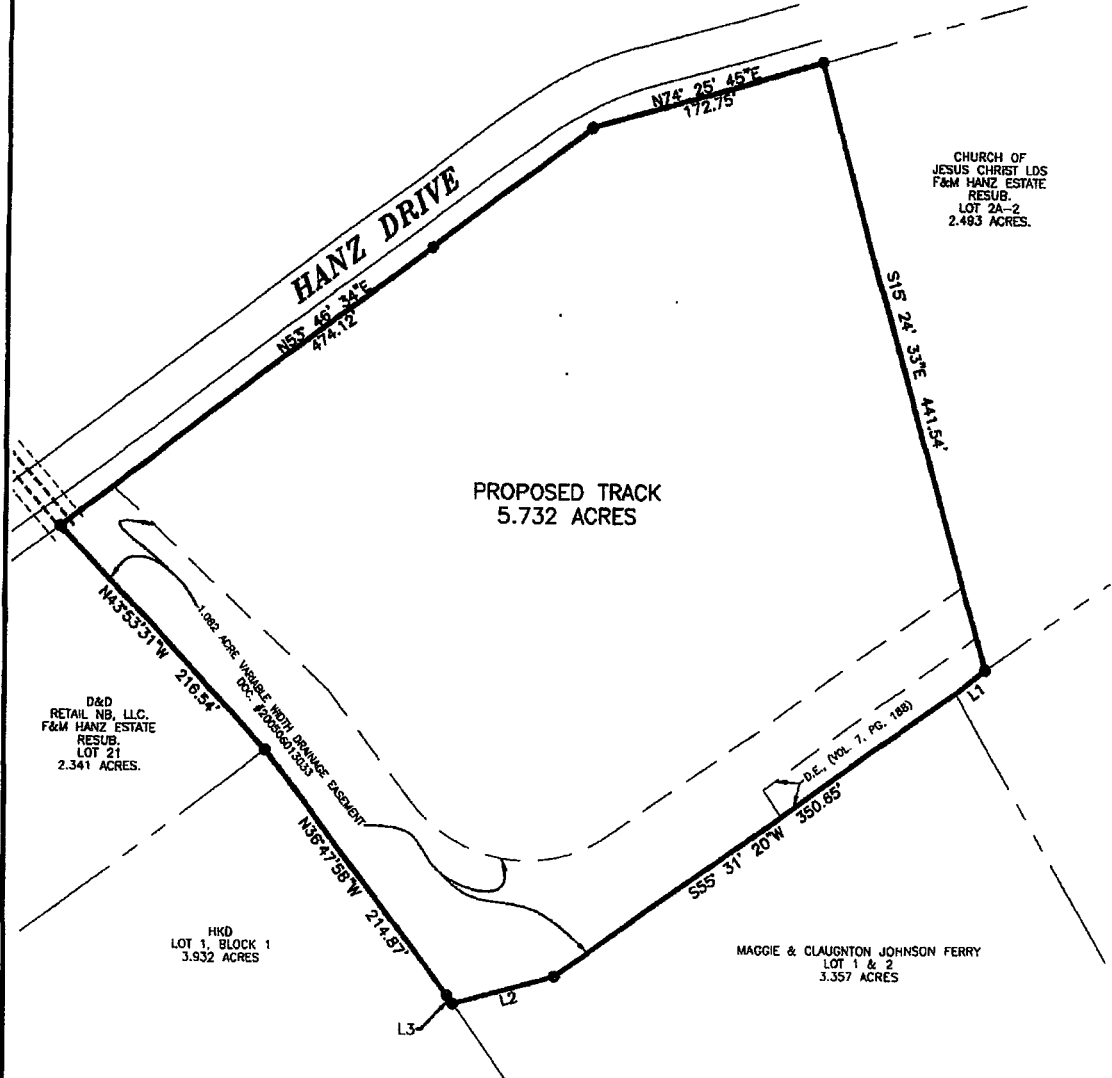

BOUNDARY & ACREAGE MAP COTTON COTTAGES

NEW BRAUNFELS

TEXAS

EXHIBIT "A"

DETAIL PLAN
ESTABLISHING
COTTON COTTAGES

1"=50'

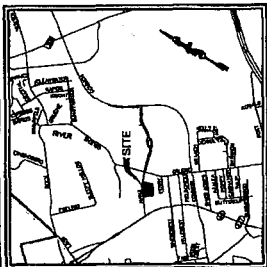

LOCATION MAP
NOT SCALE

HIGH COTTON ESTATES
COTTON COTTAGES
BLK 1-7, 36 TOTAL LOTS

QUADRAPIRE RIVER TRACT
17,266 AC/
AS DEPICTED IN A LAND TITLE
SURVEY BY BROWN ENGINEERING, CO.

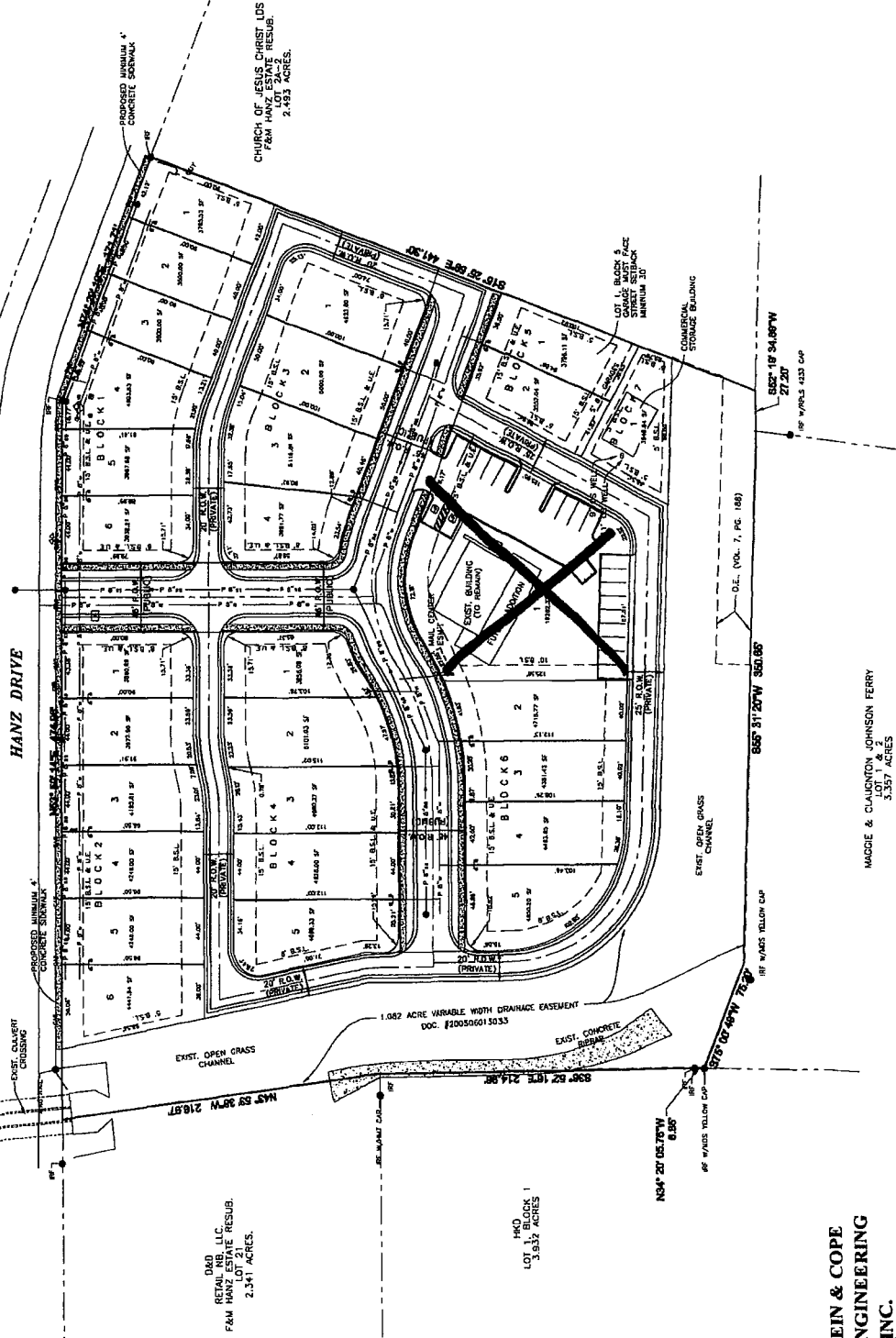

CHURCH OF JESUS CHRIST, LDS
LOT 24 & 25
2.493 ACRES.

PROPOSED MINIMUM 4'
CONCRETE SIDEWALK

LOT 16, BLOCK 5
STREET SETBACK
MINIMUM 30'

EXIST. OPEN GRASS
CHANNEL

EXIST. CONCRETE
CHANNEL

EXIST. CONCRETE
DRIVEWAY

D&D
RETAIL, INC., LLC
F&M HAZZ DRIVE
LOT 21
2.341 ACRES.

H&O
BLOCK 1
LOT 1
3.837 ACRES

MAGGIE & CLAYTON JOHNSON FERRY
LOT 1 & 2
3.077 ACRES

KLEIN & COPE
ENGINEERING
INC.
MUNICIPAL-ENVIRONMENTAL ENGINEERS
REGISTERED PROFESSIONAL ENGINEERS
TEXAS REGISTRATION # F-16278
P-2070

Amended Detail Plan

Lot 1, Block 6 Cotton Cottages

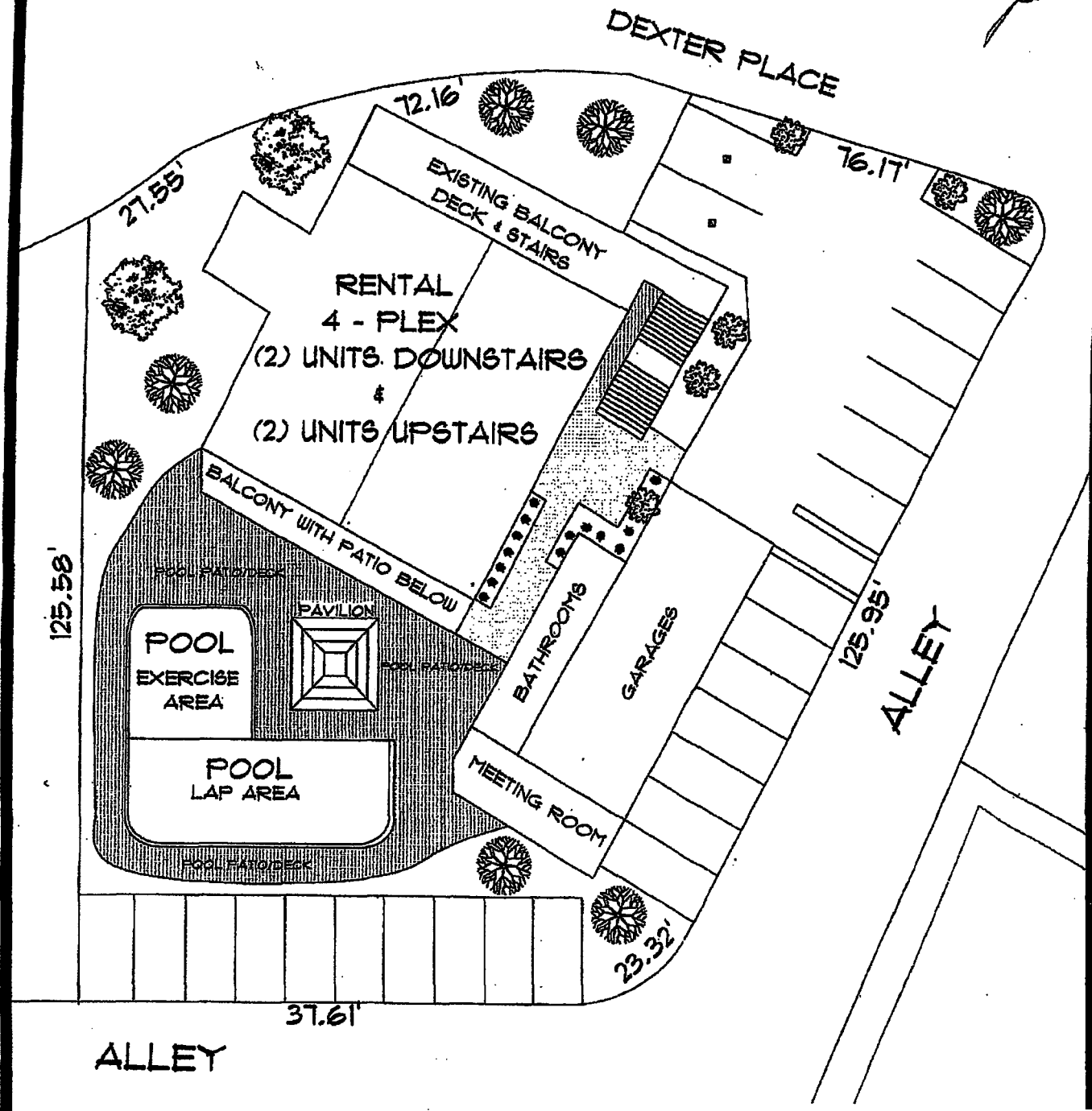
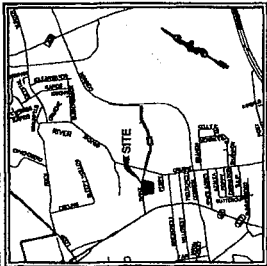

EXHIBIT 'B-2'

DETAIL PLAN
ESTABLISHING
COTTON COTTAGES



LOCATION MAP
NO SCALE

- NOTES:
1. REFERENCE THE "COTTON COTTAGES" PLANNED DEVELOPMENT DISTRICT DEVELOPMENT STANDARDS FOR THE COMPLETE REQUIREMENTS.
 2. MINIMUM SINGLE FAMILY GARDEN HOME LOT STANDARDS:
 A. LOT 4, BLS 1, LOTS 2-5 BLS 2, LOTS 1-3 BLS 3, LOTS 2-4 BLS 4, LOTS 2-4 BLS 6
 A. MINIMUM LOT AREA = 2,400 SQUARE FEET
 B. MINIMUM LOT WIDTH = 40 FEET
 C. MINIMUM LOT DEPTH = 30 FEET
 D. MINIMUM FRONT SETBACK = 15 FEET
 E. MINIMUM REAR, SIDE SETBACKS
 FRONT = 15 FEET
 REAR = 15 FEET
 SIDE = 4 FEET
 3. MINIMUM SUNDAE HOUSES LOT STANDARDS:
 A. LOT 1, 3, 5-6 BLS 1, LOTS 1, 2, 6 BLS 2, LOT 4 BLS 3, LOTS 1, 5 BLS 4, LOTS 1-2, BLS
 A. MINIMUM LOT AREA = 2,400 SQUARE FEET
 B. MINIMUM LOT WIDTH = 30 FEET
 C. MINIMUM LOT DEPTH = 30 FEET
 D. MINIMUM FRONT SETBACK = 15 FEET
 E. MINIMUM REAR, SIDE SETBACKS
 FRONT = 15 FEET
 REAR = 15 FEET
 SIDE = 4 FEET
 4. FRONT PORCHES (MINIMUM OF 5 FT. DEEP, 80 SQUARE FEET TOTAL) MAY PROJECT INTO FRONT YARD AREA, EXTENDING TO MINIMUM 1 FT. OF THE PROPERTY LINE. FRONT PORCHES ARE REAR ACCESS GARAGES WITH SIDE LOADING MAY BE 3 FT. FROM SIDE PROPERTY LINE AND 5 FEET FROM REAR PROPERTY LINE OR 15 FT. WITH GARAGE DOORS FACING ALLEY OR PRIVATE DRIVE.
 5. CORNER LOTS: ON STREET SIDE YARD MINIMUM IS 8 FT.

LOT SUMMARY	
TOTAL SITE ACRES	5.700
NO. OF UNITS	27
LAND USE	RESIDENTIAL/COMMERCIAL
RESIDENTIAL LOT ACRES	2.79
SINGLE FAMILY GARDEN HOME LOTS	151 UNITS
SUNDAE HOUSES LOTS	126 UNITS
COMMERCIAL LOT ACRES	0.31 ACRES

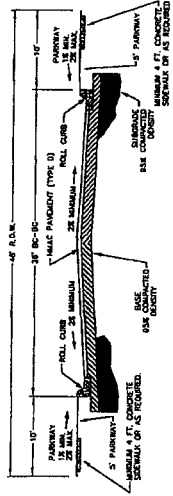

TYPICAL STREET SECTION (SEE FLOW)
NOT TO SCALE

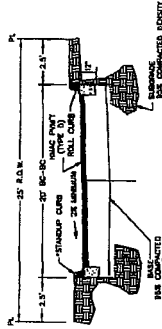

ALLEY TYPICAL STREET SECTION (SEE FLOW)
NOT TO SCALE
*MIN. GARAGE TOLERANCE

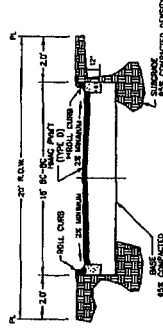

ALLEY TYPICAL STREET SECTION (SEE FLOW)
NOT TO SCALE
** STAIR UP CURB ADJACENT TO CURB PROPERTY LINE

KLEIN & COPE
ENGINEERING
INC.

MUNICIPAL • ENVIRONMENTAL ENGINEERS
2000 AVENUE 1000, SUITE 100
DALLAS, TEXAS 75201
PHONE: (214) 343-1100
FAX: (214) 343-1101

**COTTON COTTAGES BASE ZONING DISTRICT – “R-A1-6.6” SINGLE-FAMILY DISTRICT
DEVELOPMENT STANDARDS**

Sunday Homes:	Square footage 800-1800 living area Garage 1 car minimum, 2 cars maximum
Single Family Garden Homes:	Square Footage 1200 – 3000 living area Garage 2 car minimum, 3 car maximum

The PDD development is set apart from others by following these guidelines making for a sought after community.

Front porches: Required on all homes.

Garages: Must enter from alley.

Exception: Lot 1 Blk 5, garage must be set back 30' and face street.

Alleys: Rear entry garages, 5' concrete shoulder and curbs. See Details.

EXHIBIT “C”

Alley with 5' concrete shoulder detail

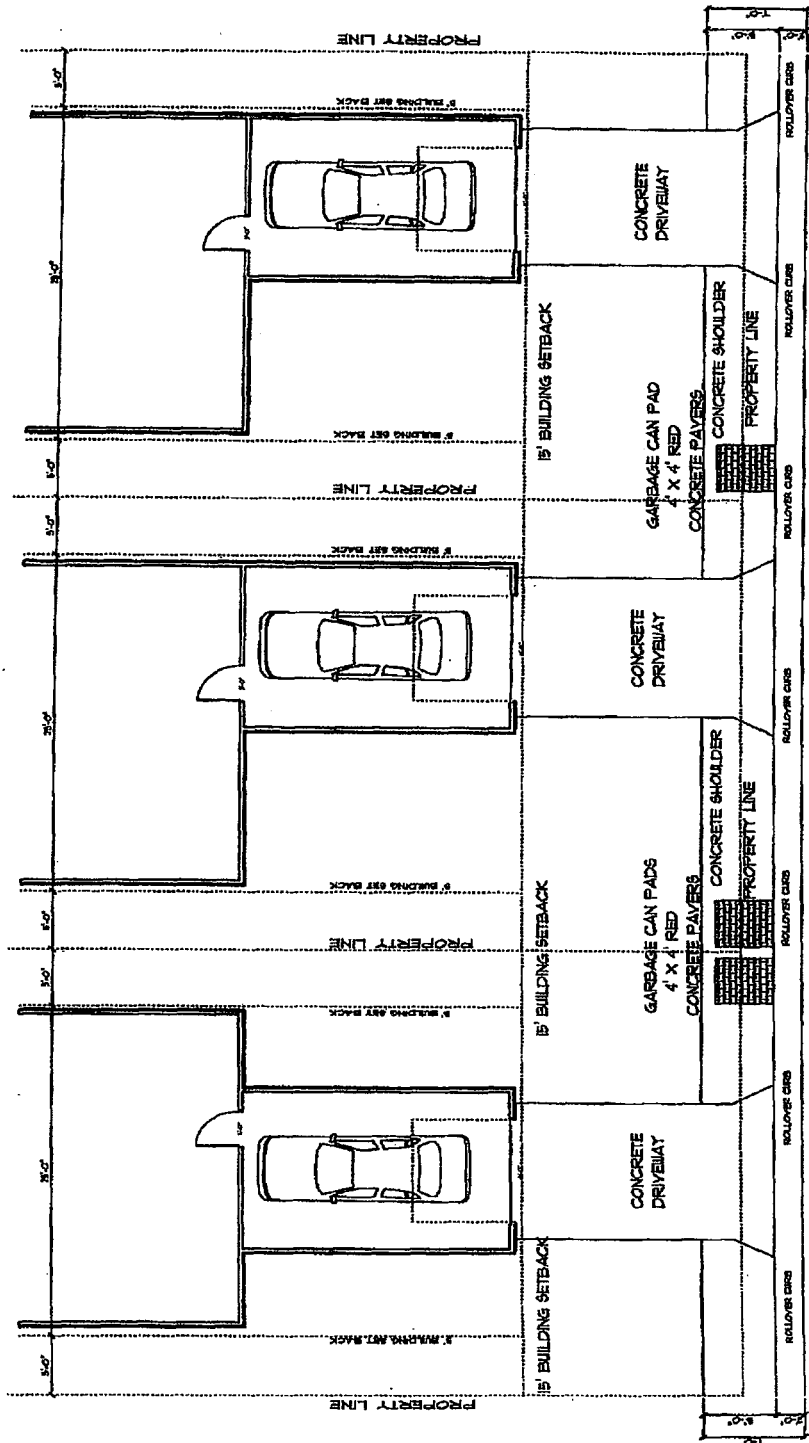

Alley Detail

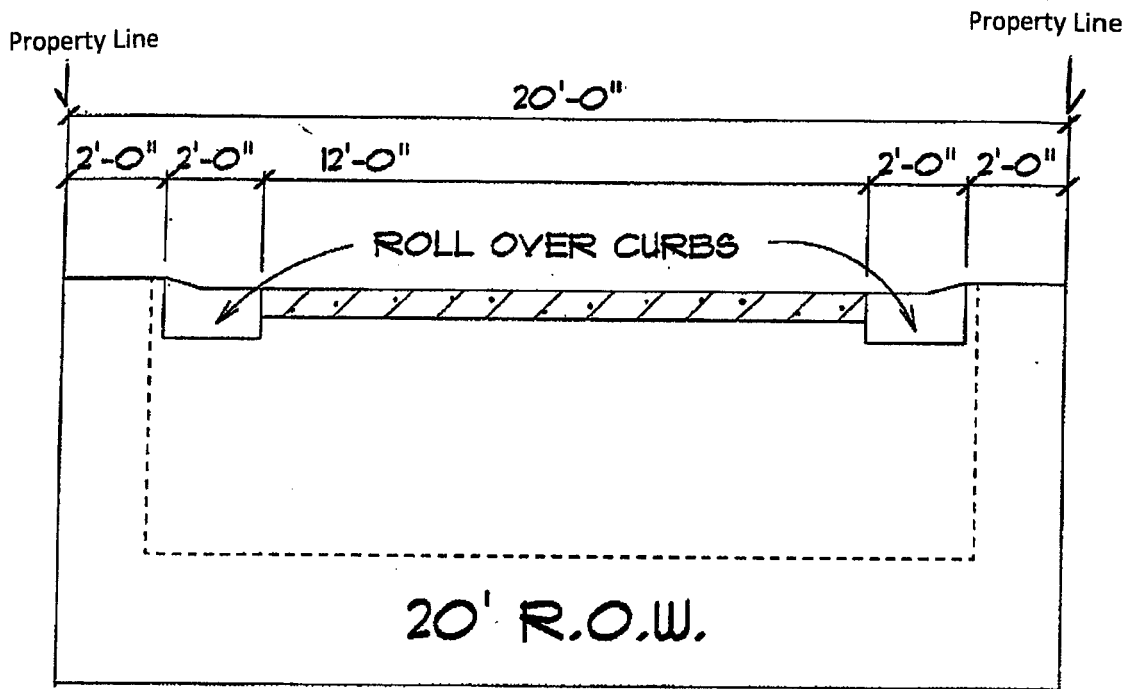

Road Detail

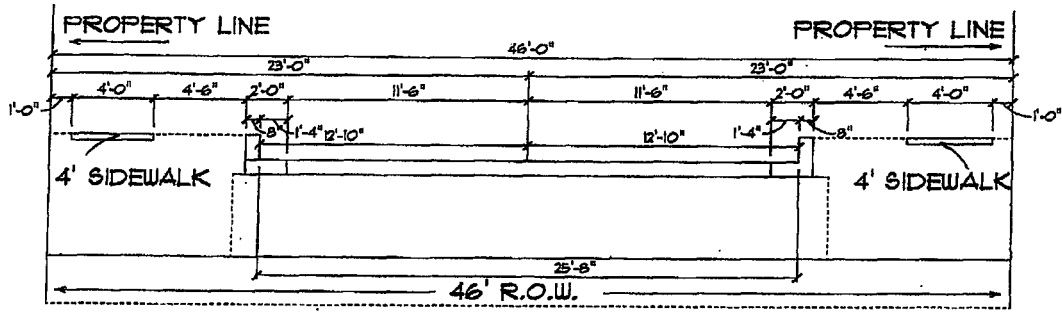

Residential Uses – Principal Buildings

Type of Residential	Minimum Lot Area	Minimum Lot Width & Depth	Principal Building Minimum Front, Side and Rear Yard Setbacks	Maximum Height	Maximum Building Coverage	Parking Minimum
SFD-G: Single Family Garden Homes	3600 SF	40FT./90FT.	FY: 15 FT. SY: 5 FT. RY: 15 FT.	35 FT. 2.5 Stories	60%	2 spaces/unit enclosed
SFA-C Cottages, Sunday Houses	2400 SF/single unit	30FT/80FT	FY: 15 FT. SY: 5 FT. RY: 15 FT.	25 FT. 2 Stories	60%	1 Space/Unit enclosed

Notes:

- 1.) Front porches (minimum of 5ft. deep, 80 square feet total) may project into front yard area, extending to within 10ft. of the property line. Front porches are required on all residential units.
- 2.) Rear access garages with side loading may be 3 ft. from side property line and 5 ft. from rear property line or 15ft. with garage doors facing alley or private rear access drive. Except: LOT 1 BLK 5, garage must face street with a minimum front setback of 30'
- 3.) Corner lots: On-street side yard minimum is 8 ft.
- 4.) Allowable yard projections: (Front porches – see above)
Horizontal- Roof overhangs, bay windows, canopies 12" Minimum, Balconies 5' (front or rear)
Vertical- (above maximum, height), chimneys; 6'; cupolas: 8'; observations towers: 8'

Commercial Uses – Principal Buildings

Principal Building Minimum Front, Side and Rear Yard Setbacks	Maximum Height	Maximum Building Coverage
FY: 15 FT. SY: 5 FT. RY: 5 FT.	40 FT. 2.5 Stories	60%

Outbuilding/ Storage Building	Maximum Height	Maximum Building Coverage
FY: 5 FT. SY: 5 FT. RY: 5 FT.	25 FT. 1 Story	60%

Notes:

- 1.) Front porches may project into front setback 5'.
- 2.) Balconies may project into front and rear set back 5'.
- 3.) New construction on Lot 1, Block 6 will require a minimum setback of 10 feet plus one foot for each foot of building height over 20 feet where adjacent a residential property line.

Authorized Uses for Commercial Lots

- Adult day care (no overnight stay).
- Adult day care (with overnight stay).
- Antique shop.
- Artist or artisan's studio.
- Barber/beauty shop, haircutting (non-college).
- Bed and breakfast establishments.
- Book store.
- Clinic (dental).
- Clinic (medical).
- Coffee Shop.
- Community building (associated with residential uses)
- Confectionery store (retail).
- Contractor's temporary on-site construction office (only with permit from building official; see section 144-5.10.
- Exercise and physical therapy
- Florist.
- Garden shops and greenhouses.
- Handicraft shop.
- Kiosk (providing retail service).
- Laundromat and laundry pickup stations.
- Needlework shop.
- Offices, business or professional.
- Photographic studio (no sale of cameras or supplies).
- Park and/or playground/pool (public or private).
- Refreshment/beverage stand.
- Restaurant/prepared foods.
- Specialty shops in support of project guests and tourists.
- Storage out building ("Restricted to enclosed private storage limited to use by the developer for storage of contractor's equipment, storage for the subdivision's Home Owner's Association and or storage for the tenants of the commercial building on Lot 1, Block 6".)
- Stores, shops and markets for neighborhood retail trade.
- Studios (art, dance, music, drama, reducing, exercise, photo, interior decorating, etc.).
- Water storage (surface, underground or overhead tanks).
- Water well ("Restricted to the existing on-site water well. No new water wells are permitted. The use of the existing water well will be limited to irrigation use by the two commercial lots (Lot 1, Block 6 and Lot 1, Block 7). Water well usage is restricted to New Braunfels Utilities water irrigation regulations.")

The following are additional uses permitted on Lot 1, Block 6.

- Maximum of 4 residential rental units (no short term rental; minimum 30 day lease).
- Patios and decks.
- Garages and storage buildings for tenants and or property maintenance.
- A pool, pool patio and pool pavilion for residents of the neighborhood - limited to use by residents of the subdivision.
- A meeting room - limited to use by residents of the subdivision.
- Bathrooms - limited to use by residents of the subdivision.

Proposed Street Standards

Street	Design Speed	Classification	ROW	Pavement Width	Curb Type Shoulder	On-Street Parking
Minor Internal	20 MPH	Residential Minor	46 Ft.	23 Ft.	City of New Braunfels Standard Curb	One Side Only
Alley or Private Rear Access Drive	15 MPH	Rear Garage Access way or shared drive	20 - 25 Ft.	16 - 20Ft.	Roll Over & City of New Braunfels Standard Curb	None

NOTES:

- 1.) Pavement (asphalt) widths include 24" wide concrete curb and gutter section.
- 2.) Design speed is not the actual speed limit.

Relationship of these PDD standards to other standards and regulations in the City ordinances.
Unless specifically described in these regulations, or further described in the Detailed PDD Plan, the applicable provisions of the City's Zoning and Subdivisions Regulations shall apply to the PDD.

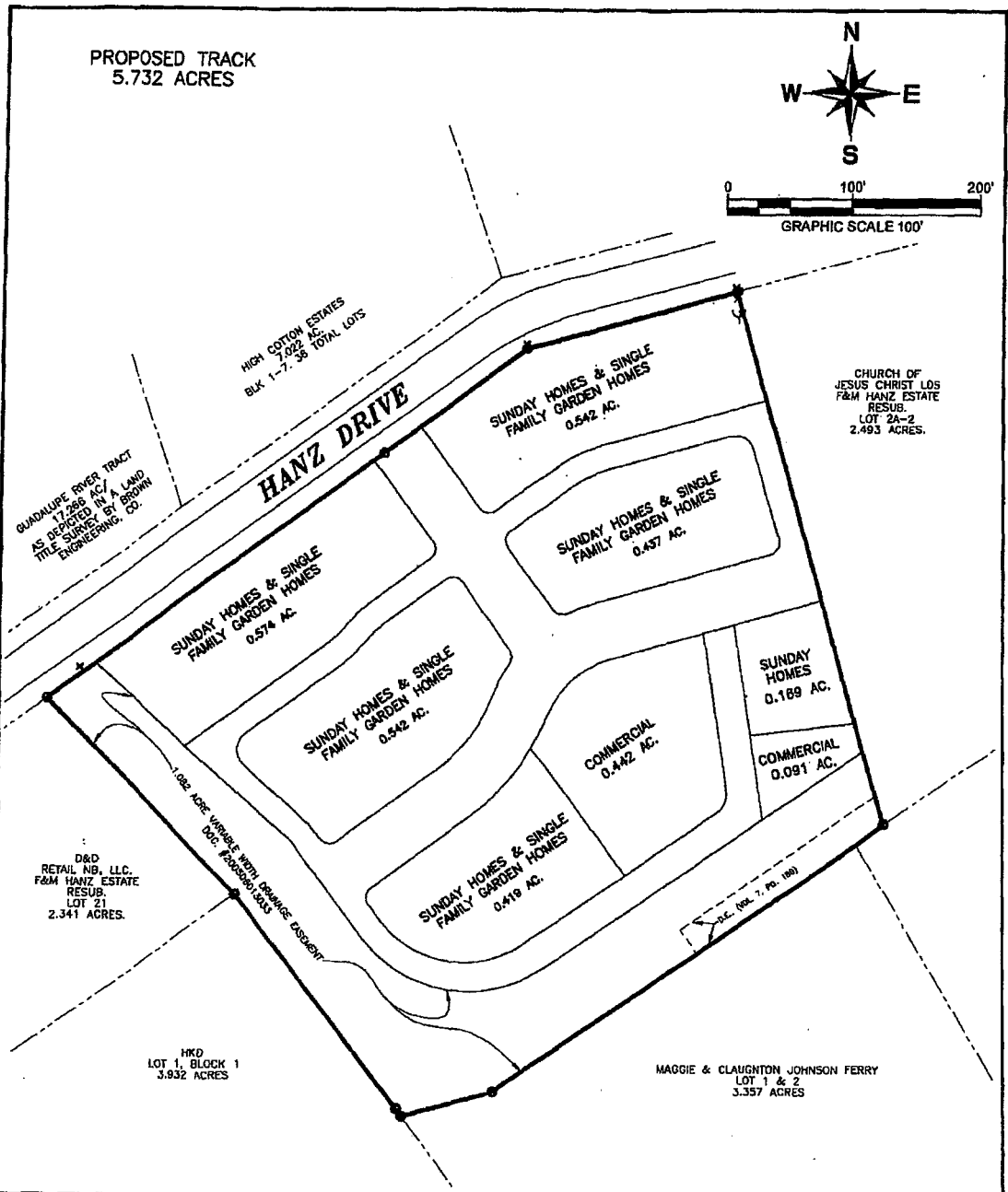

 <p>KLEIN & COPE ENGINEERING INC.</p> <p><small>CIVIL, MECHANICAL, ENVIRONMENTAL ENGINEERS 1111 WEST 12TH STREET DALLAS, TEXAS 75204 TEL: 972-443-1111 FAX: 972-443-1112 www.kleinandcope.com</small></p>	<p>PROPOSED LAND USE MAP COTTON COTTAGES</p> <p>NEW ROAD INCE 1 S</p>	<p>TEXAS</p>
---	---	--------------

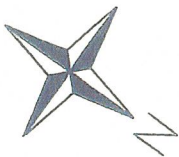

SCALE: 1"=100'

PRIVATE RES

PRIVATE RES

CUBE SMART
MINI STORAGE
(ENCLOSED)

D.&C.D.

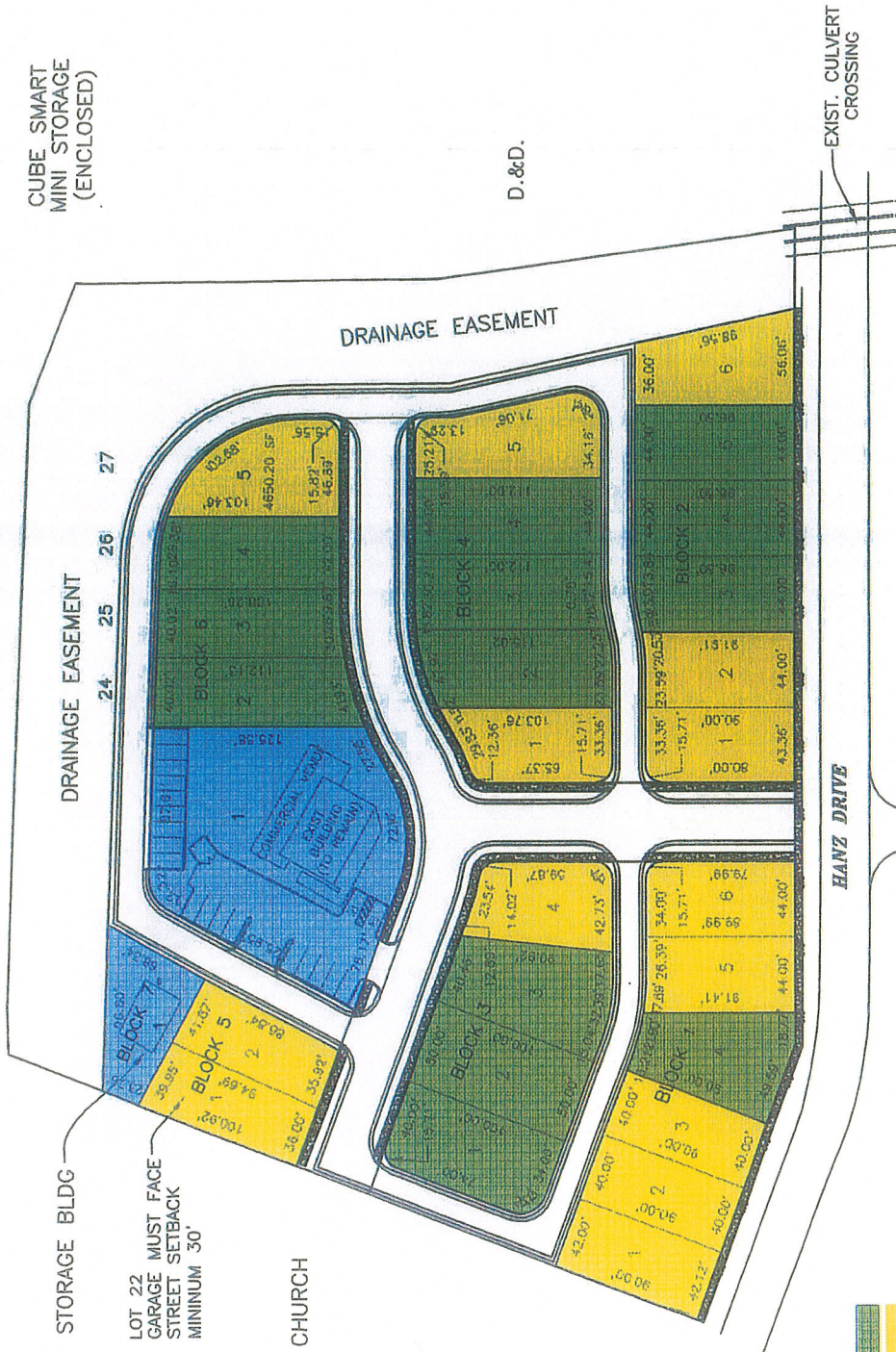

GARDEN HOMES LOT
 SUNDAY HOME LOT
 COMMERCIAL LOT

HIGH COTTON ESTATES

COTTON COTTAGES