

ORDINANCE NO. 2019-

AN ORDINANCE OF THE CITY COUNCIL OF THE CITY OF NEW BRAUNFELS, TEXAS, AMENDING THE "COTTON COTTAGES" PLANNED DEVELOPMENT DISTRICT (CCPD) CONCEPT PLAN, DETAIL PLAN AND RELATED DEVELOPMENT STANDARDS; REPEALING ALL ORDINANCES IN CONFLICT; CONTAINING A SAVINGS CLAUSE; AND DECLARING AN EFFECTIVE DATE.

WHEREAS, the City Council of the City of New Braunfels has complied with all requirements of notice of public hearing as required by the Zoning Ordinance of the City of New Braunfels; and

WHEREAS, in keeping with the spirit and objectives of the "PD" Planned Development District, the City Council has given due consideration to all components of said district; and

WHEREAS, it is the intent of the City Council to provide harmony between existing zoning districts and proposed land uses; and

WHEREAS, the City Council desires to amend the "Cotton Cottages" Planned Development District Concept Plan, Detail Plan and Development Standards; **now, therefore;**

BE IT ORDAINED BY THE CITY COUNCIL OF THE CITY OF NEW BRAUNFELS, TEXAS:

SECTION 1

THAT the "Cotton Cottages" Planned Development District Concept Plan, Detail Plan and Development Standards adopted by City Council May 9, 2016 are hereby amended by adopting the following described Amended Concept Plan, Amended Detail Plan and Amended Development Standards:

"Known as 5.732 acres out of Lot 2A-1, F & M Hanz Estate Resubdivision, Comal County, Texas, as delineated on Exhibit 'A', and adopting the Amended Concept Plan depicted on Exhibit 'B', the Amended Detail Plan as depicted on Exhibits 'C-1' and 'C-2' and the Amended Development Standards described in Exhibit 'D' attached.

SECTION 2

THAT all provisions of the Code of Ordinances of the City of New Braunfels not herein amended or repealed shall remain in full force and effect.

SECTION 3

THAT all other ordinances, or parts of ordinances, in conflict herewith are hereby repealed to the extent that they are in conflict.

SECTION 4

THAT if any provisions of this ordinance shall be held void or unconstitutional, it is hereby provided that all other parts of the same which are not held void or unconstitutional shall remain in full force and effect.

SECTION 5

THIS ordinance will take effect upon the second and final reading in accordance with the provisions of the Charter of the City of New Braunfels.

PASSED AND APPROVED: First reading this 22nd day of April, 2019.

PASSED AND APPROVED: Second reading this 13th day of May, 2019.

CITY OF NEW BRAUNFELS

BARRON CASTEEL, Mayor

ATTEST:

PATRICK D. ATEN, City Secretary

APPROVED AS TO FORM:

VALERIA M. ACEVEDO, City Attorney

\\chfs-1\Departments\Planning\ZoneChange-SUP-Replats\2019 Cases\IPZ-19-003 Ordinance.docx

LINE TABLE		
LINE	LENGTH	BEARING
L1	27.20'	S 52°19'35" W
L2	75.21'	S 74°48'31" W
L3	7.20'	N 35°43'46" W

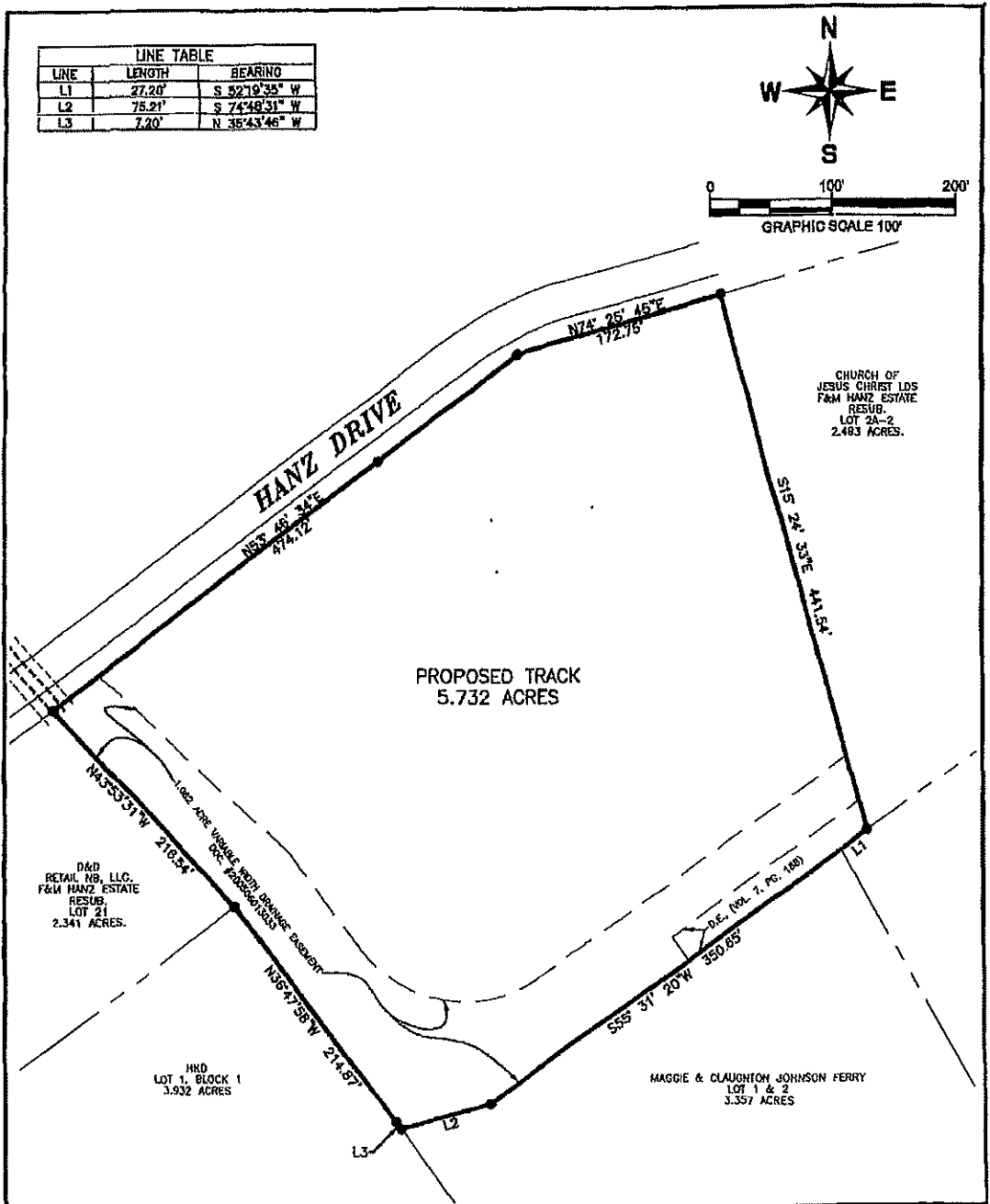

**BOUNDARY & ACREAGE MAP
COTTON COTTAGES**

NEW BRAUNFELS

TEXAS

"COTTON COTTAGES" PLANNED DEVELOPMENT DISTRICT CONCEPT PLAN

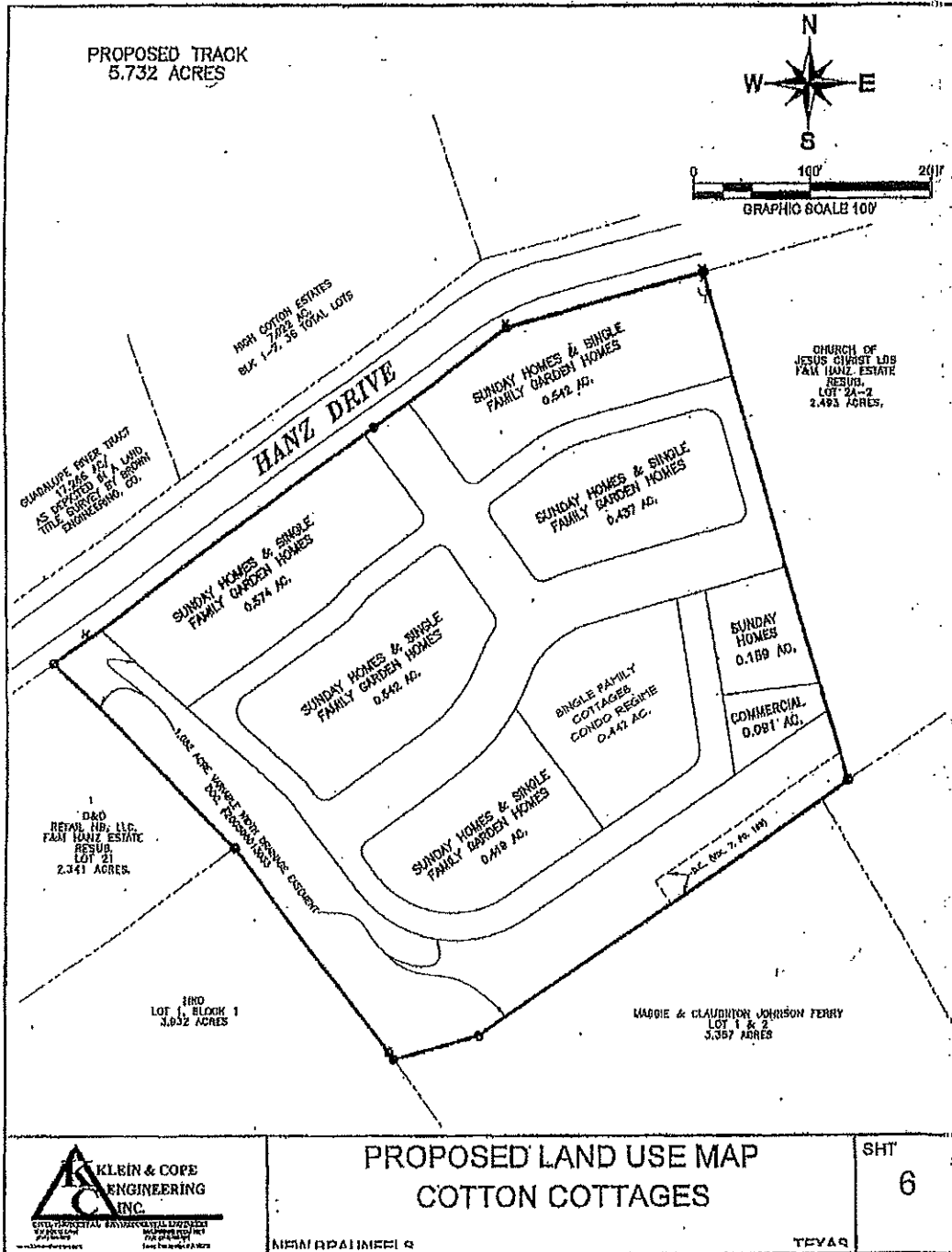

"COTTON COTTAGES" PLANNED DEVELOPMENT DISTRICT DETAIL PLAN



DETAIL PLAN
ESTABLISHING
COTTON COTTAGES



HIGH COTTON DEWITES
2,322 ACROSS
BLK 1-2, 26 TOTAL LOTS

CHUCKLEBERRY TRACT
17,246 AC.
AS DEPICTED IN LAND TITLE
SURRENDERED BY BROWN DEVELOPMENT, CO.

LOCATION MAP
AS SHOWN

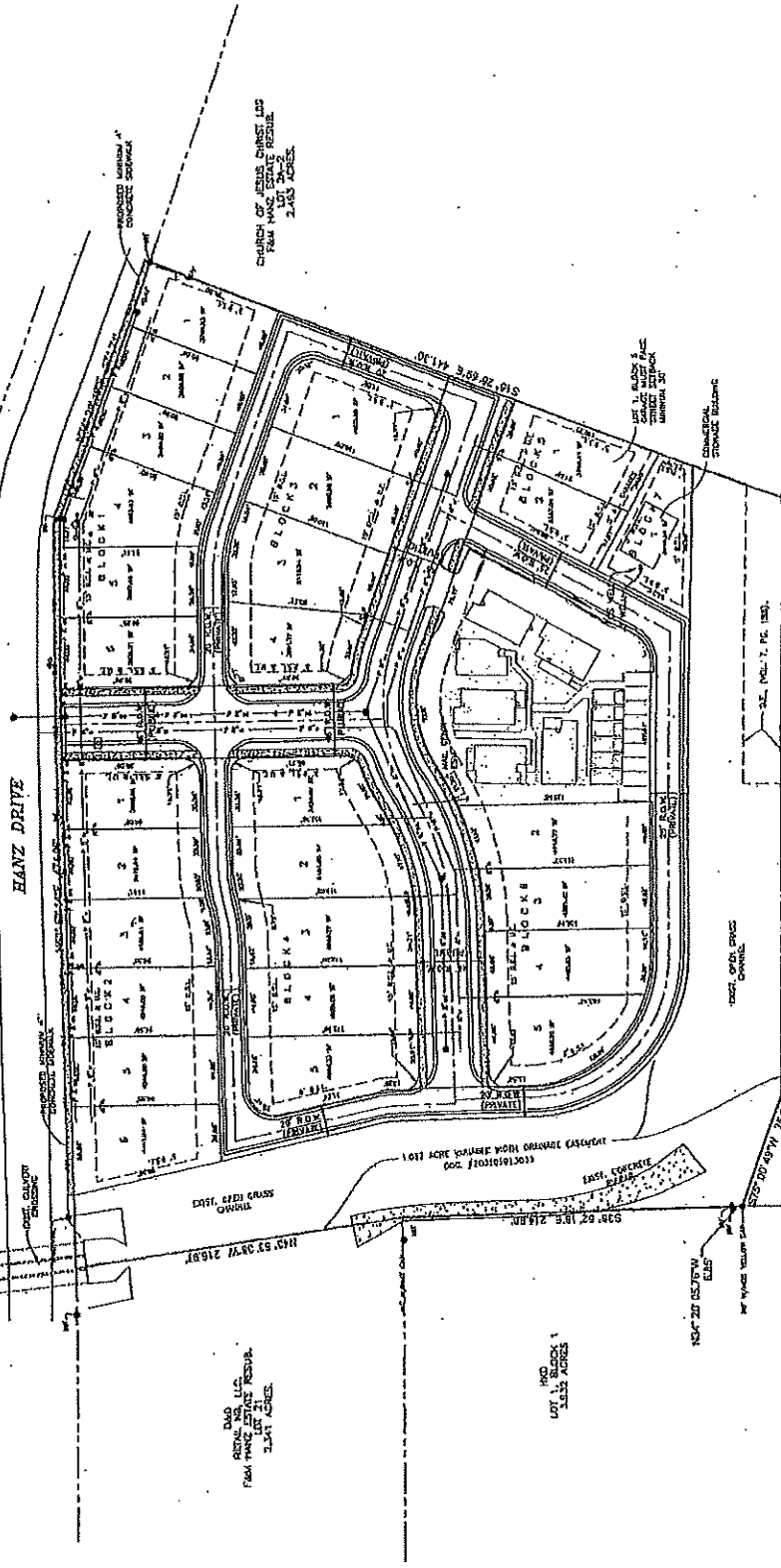

DAVID M. L.L.C.
FARM TRACT 101
3.14 ACRES

100
LOT 15, BLOCK 1
2.14 ACRES

KLEIN & COPE
ENGINEERING
INC.
CIVIL-MUNICIPAL-ENVIRONMENTAL ENGINEERS
400 WEST LAMAR
MEMPHIS, TENN 38107
TEL: (901) 525-1111
FAX: (901) 525-1112

JACQUE & CLAUDINE JOHNSON FERRY
LOT 1, ACRES
3.257 ACRES

SHT 1 OF 2

SHT 1 OF 2

DETAIL PLAN
ESTABLISHING
COTTON COTTAGES



- NOTES:
1. REFERENCE THE "COTTON COTTAGES" PLANNED DEVELOPMENT DISTRICT DEVELOPMENT STANDARDS FOR THE COMPLETE REQUIREMENTS.
 2. MINIMUM SINGLE FAMILY GARDEN HOME LOT STANDARDS:
 A. MINIMUM LOT AREA = 3,200 SQUARE FEET
 B. MINIMUM LOT WIDTH = 40 FEET
 C. MINIMUM LOT DEPTH = 40 FEET
 D. MINIMUM LOT FRONT, REAR, SIDE SETBACKS
 FRONT = 10 FEET
 REAR = 10 FEET
 SIDE = 5 FEET
 E. MINIMUM DRIVEWAY HOUSES LOT STANDARDS:
 1. LOTS 1, 2, 3, 4, 5, 6, 7, 8, 9, 10, 11, 12, 13, 14, 15, 16, 17, 18, 19, 20, 21, 22, 23, 24, 25, 26, 27, 28, 29, 30, 31, 32, 33, 34, 35, 36, 37, 38, 39, 40, 41, 42, 43, 44, 45, 46, 47, 48, 49, 50, 51, 52, 53, 54, 55, 56, 57, 58, 59, 60, 61, 62, 63, 64, 65, 66, 67, 68, 69, 70, 71, 72, 73, 74, 75, 76, 77, 78, 79, 80, 81, 82, 83, 84, 85, 86, 87, 88, 89, 90, 91, 92, 93, 94, 95, 96, 97, 98, 99, 100, 101, 102, 103, 104, 105, 106, 107, 108, 109, 110, 111, 112, 113, 114, 115, 116, 117, 118, 119, 120, 121, 122, 123, 124, 125, 126, 127, 128, 129, 130, 131, 132, 133, 134, 135, 136, 137, 138, 139, 140, 141, 142, 143, 144, 145, 146, 147, 148, 149, 150, 151, 152, 153, 154, 155, 156, 157, 158, 159, 160, 161, 162, 163, 164, 165, 166, 167, 168, 169, 170, 171, 172, 173, 174, 175, 176, 177, 178, 179, 180, 181, 182, 183, 184, 185, 186, 187, 188, 189, 190, 191, 192, 193, 194, 195, 196, 197, 198, 199, 200, 201, 202, 203, 204, 205, 206, 207, 208, 209, 210, 211, 212, 213, 214, 215, 216, 217, 218, 219, 220, 221, 222, 223, 224, 225, 226, 227, 228, 229, 230, 231, 232, 233, 234, 235, 236, 237, 238, 239, 240, 241, 242, 243, 244, 245, 246, 247, 248, 249, 250, 251, 252, 253, 254, 255, 256, 257, 258, 259, 260, 261, 262, 263, 264, 265, 266, 267, 268, 269, 270, 271, 272, 273, 274, 275, 276, 277, 278, 279, 280, 281, 282, 283, 284, 285, 286, 287, 288, 289, 290, 291, 292, 293, 294, 295, 296, 297, 298, 299, 300, 301, 302, 303, 304, 305, 306, 307, 308, 309, 310, 311, 312, 313, 314, 315, 316, 317, 318, 319, 320, 321, 322, 323, 324, 325, 326, 327, 328, 329, 330, 331, 332, 333, 334, 335, 336, 337, 338, 339, 340, 341, 342, 343, 344, 345, 346, 347, 348, 349, 350, 351, 352, 353, 354, 355, 356, 357, 358, 359, 360, 361, 362, 363, 364, 365, 366, 367, 368, 369, 370, 371, 372, 373, 374, 375, 376, 377, 378, 379, 380, 381, 382, 383, 384, 385, 386, 387, 388, 389, 390, 391, 392, 393, 394, 395, 396, 397, 398, 399, 400, 401, 402, 403, 404, 405, 406, 407, 408, 409, 410, 411, 412, 413, 414, 415, 416, 417, 418, 419, 420, 421, 422, 423, 424, 425, 426, 427, 428, 429, 430, 431, 432, 433, 434, 435, 436, 437, 438, 439, 440, 441, 442, 443, 444, 445, 446, 447, 448, 449, 450, 451, 452, 453, 454, 455, 456, 457, 458, 459, 460, 461, 462, 463, 464, 465, 466, 467, 468, 469, 470, 471, 472, 473, 474, 475, 476, 477, 478, 479, 480, 481, 482, 483, 484, 485, 486, 487, 488, 489, 490, 491, 492, 493, 494, 495, 496, 497, 498, 499, 500, 501, 502, 503, 504, 505, 506, 507, 508, 509, 510, 511, 512, 513, 514, 515, 516, 517, 518, 519, 520, 521, 522, 523, 524, 525, 526, 527, 528, 529, 530, 531, 532, 533, 534, 535, 536, 537, 538, 539, 540, 541, 542, 543, 544, 545, 546, 547, 548, 549, 550, 551, 552, 553, 554, 555, 556, 557, 558, 559, 560, 561, 562, 563, 564, 565, 566, 567, 568, 569, 570, 571, 572, 573, 574, 575, 576, 577, 578, 579, 580, 581, 582, 583, 584, 585, 586, 587, 588, 589, 590, 591, 592, 593, 594, 595, 596, 597, 598, 599, 600, 601, 602, 603, 604, 605, 606, 607, 608, 609, 610, 611, 612, 613, 614, 615, 616, 617, 618, 619, 620, 621, 622, 623, 624, 625, 626, 627, 628, 629, 630, 631, 632, 633, 634, 635, 636, 637, 638, 639, 640, 641, 642, 643, 644, 645, 646, 647, 648, 649, 650, 651, 652, 653, 654, 655, 656, 657, 658, 659, 660, 661, 662, 663, 664, 665, 666, 667, 668, 669, 670, 671, 672, 673, 674, 675, 676, 677, 678, 679, 680, 681, 682, 683, 684, 685, 686, 687, 688, 689, 690, 691, 692, 693, 694, 695, 696, 697, 698, 699, 700, 701, 702, 703, 704, 705, 706, 707, 708, 709, 710, 711, 712, 713, 714, 715, 716, 717, 718, 719, 720, 721, 722, 723, 724, 725, 726, 727, 728, 729, 730, 731, 732, 733, 734, 735, 736, 737, 738, 739, 740, 741, 742, 743, 744, 745, 746, 747, 748, 749, 750, 751, 752, 753, 754, 755, 756, 757, 758, 759, 760, 761, 762, 763, 764, 765, 766, 767, 768, 769, 770, 771, 772, 773, 774, 775, 776, 777, 778, 779, 780, 781, 782, 783, 784, 785, 786, 787, 788, 789, 790, 791, 792, 793, 794, 795, 796, 797, 798, 799, 800, 801, 802, 803, 804, 805, 806, 807, 808, 809, 810, 811, 812, 813, 814, 815, 816, 817, 818, 819, 820, 821, 822, 823, 824, 825, 826, 827, 828, 829, 830, 831, 832, 833, 834, 835, 836, 837, 838, 839, 840, 841, 842, 843, 844, 845, 846, 847, 848, 849, 850, 851, 852, 853, 854, 855, 856, 857, 858, 859, 860, 861, 862, 863, 864, 865, 866, 867, 868, 869, 870, 871, 872, 873, 874, 875, 876, 877, 878, 879, 880, 881, 882, 883, 884, 885, 886, 887, 888, 889, 890, 891, 892, 893, 894, 895, 896, 897, 898, 899, 900, 901, 902, 903, 904, 905, 906, 907, 908, 909, 910, 911, 912, 913, 914, 915, 916, 917, 918, 919, 920, 921, 922, 923, 924, 925, 926, 927, 928, 929, 930, 931, 932, 933, 934, 935, 936, 937, 938, 939, 940, 941, 942, 943, 944, 945, 946, 947, 948, 949, 950, 951, 952, 953, 954, 955, 956, 957, 958, 959, 960, 961, 962, 963, 964, 965, 966, 967, 968, 969, 970, 971, 972, 973, 974, 975, 976, 977, 978, 979, 980, 981, 982, 983, 984, 985, 986, 987, 988, 989, 990, 991, 992, 993, 994, 995, 996, 997, 998, 999, 1000.

LOT SUMMARY	
TOTAL SITE ACREAGE	8.7281
NO. OF LOTS	27
LAND USE	RESIDENTIAL/COMMERCIAL
MINIMUM LOT ACREAGE	0.379
SINGLE PARCELS PER ACRE	1.91
MINIMUM LOT ACREAGE	0.379
MINIMUM LOT ACREAGE	0.379

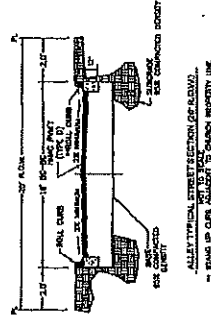
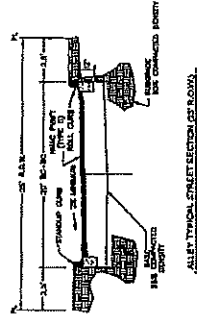
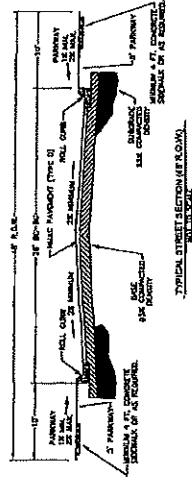

KLEIN & COPE
ENGINEERING
INC.

REGISTERED PROFESSIONAL ENGINEERS
REGISTERED PROFESSIONAL LAND SURVEYORS
REGISTERED PROFESSIONAL ARCHITECTS
REGISTERED PROFESSIONAL PLANNERS

**COTTON COTTAGES BASE ZONING DISTRICT – “R-A1-6.6” SINGLE-FAMILY DISTRICT
DEVELOPMENT STANDARDS**

Sunday Homes:	Square footage 800-1800 living area Garage 1 car minimum, 2 cars maximum
Single Family Garden Homes:	Square Footage 1200 – 3000 living area Garage 2 car minimum, 3 car maximum

The PDD development is set apart from others by following these guidelines making for a sought after community.

Front porches: Required on all homes.

Garages: Must enter from alley.

Exception: Lot 1 Blk 5, garage must be set back 30' and face street.

Alleys: Rear entry garages, 5' concrete shoulder and curbs. See Details.

Alley with 5' concrete shoulder detail

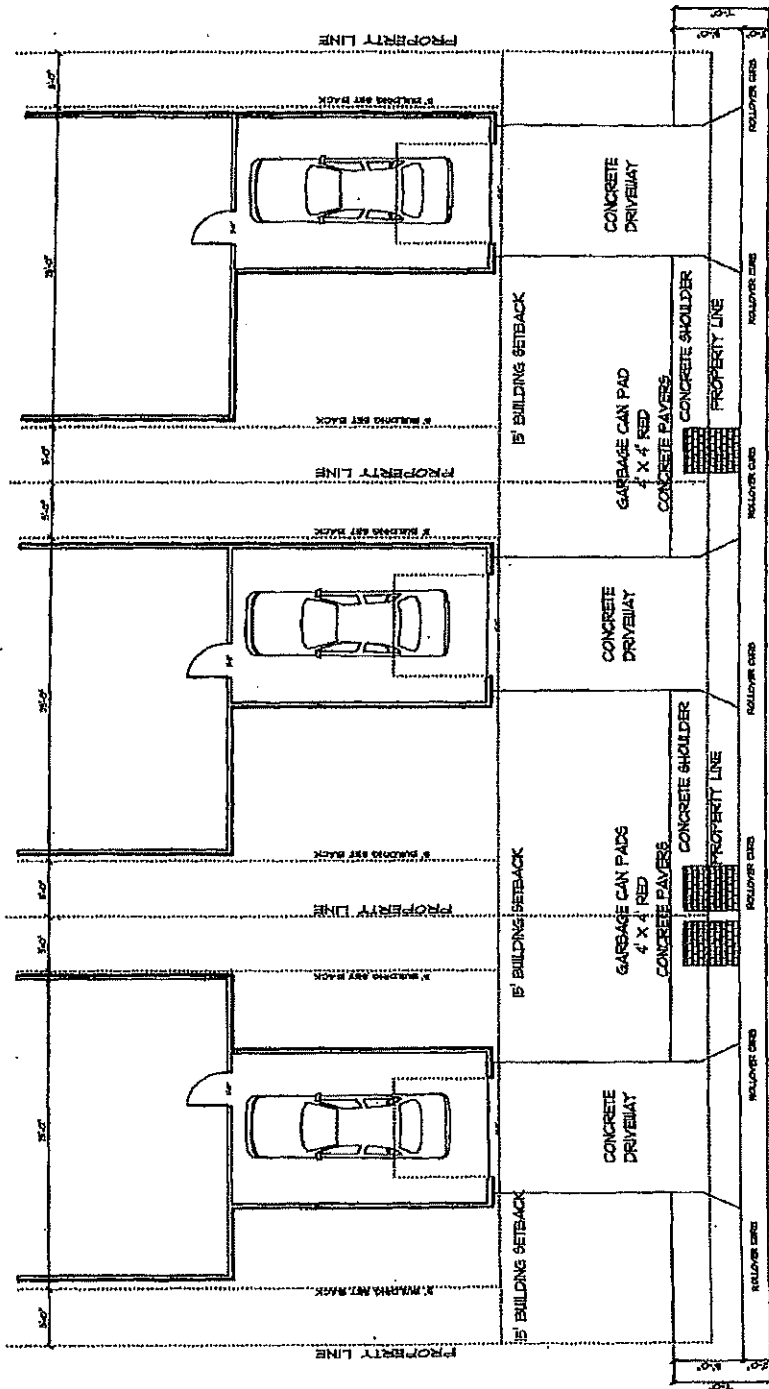

Alley Detail

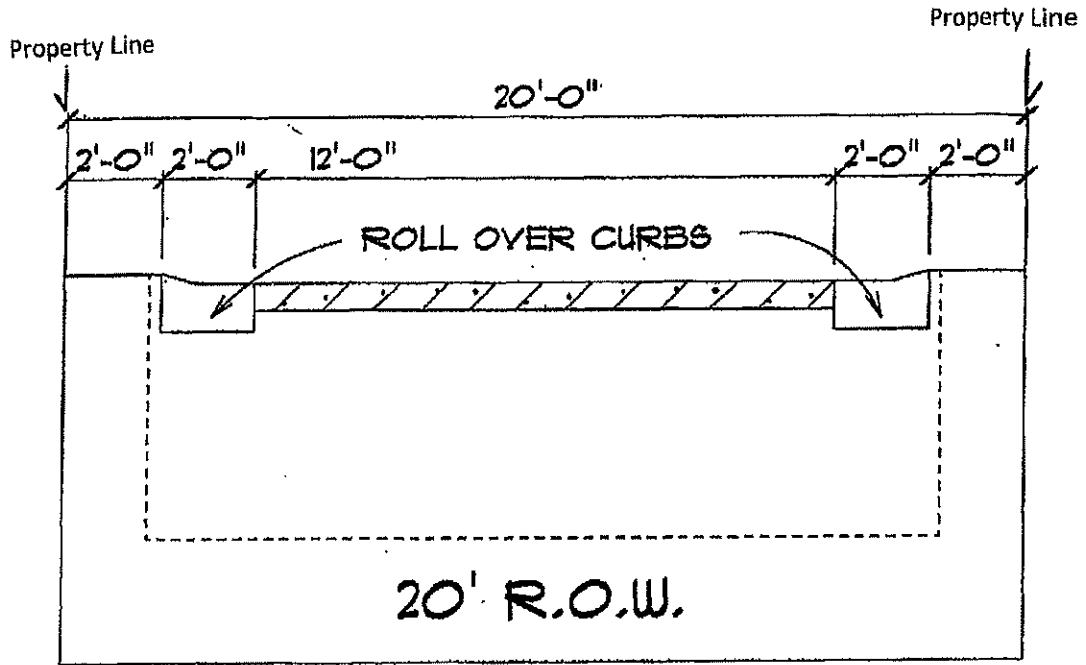

Road Detail

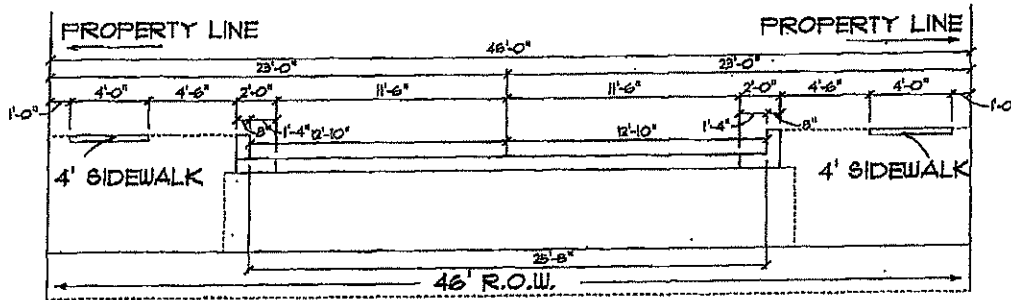

Residential Uses – Principal Building Development Standards

Type of Residential	Minimum Lot Area	Minimum Lot Width & Depth	Principal Building Minimum Front, Side and Rear Yard Setbacks	Maximum Height	Maximum Building Coverage	Parking Minimum
SFD-G: Single Family Garden Homes	3600 SF	40FT./ 90FT.	FY: 15 FT. SY: 5 FT. RY: 15 FT.	35 FT. 2.5 Stories	60%	2 spaces/unit enclosed
SFA-C Cottages, Sunday Houses	2400 SF/single unit	30FT/80FT	FY: 15 FT. SY: 5 FT. RY: 15 FT.	25 FT. 2 Stories	60%	1 Space/ Unit enclosed

Notes:

1.) Front porches (minimum of 5ft. deep, 80 square feet total) may project into front yard area, extending to within 10ft. of the property line. Front porches are required on all residential units.

2.) Rear access garages with side loading may be 3 ft. from side property line and 5 ft. from rear property line or 15ft. with garage doors facing alley or private rear access drive. Except: LOT 1 BLK 5, garage must face street with a minimum front setback of 30'

3.) Corner lots: On-street side yard minimum is 8 ft.

4.) Allowable yard projections: (Front porches – see above)

Horizontal- Roof overhangs, bay windows, canopies 12" Minimum, Balconies 5' (front or rear)

Vertical- (above maximum, height), chimneys; 6'; cupolas: 8'; observations towers: 8'

Residential uses - Lot 1, Blk 6, Development Standards

TYPE OF RESIDENTIAL	MIN BLDG SET BACKS	MAX HEIGHT	MAX BLDGS COVERAGE	PARKING
6FA - C COTTAGES CONDO REGIME	15FT. FRONT 15 FT. REAR 10 FT. INTERIOR SIDE* 5FT. SIDE ADJACENT TO ALLEY 10 FT. BETWEEN BUILDINGS	35 FT. / TWO STORY	70%	1 - CAR GARAGE EACH UNIT

- NOTE: 1. FRONT PROCHES AND/OR SIDE OR REAR PATIOS REQUIRED ON ALL UNITS
2. BALCONIES ALLOWED AT FRONT, REAR OR SIDE OF UNITS
3. *NEW CONSTRUCTION ON LOT 1, BLOCK 6 WILL REQUIRE A MINIMUM SETBACK OF 10 FEET PLUS ONE-FOOT FOR EACH FOOT OF BUILDING HEIGHT OVER 20 FEET WHERE ADJACENT TO A SINGLE FAMILY RESIDENTIAL PROPERTY LINE

Lot 1, Block 7 Development Standards

Outbuilding/ Storage Building	Maximum Height	Maximum Building Coverage
FY: 5 FT. SY: 5 FT. RY: 5 FT.	25 FT. 1 Story	60%

Notes:

- 1.) Front porches may project into front setback 5'.
- 2.) Balconies may project into front and rear set back 5'.

Proposed Street Standards

Street	Design Speed	Classification	ROW	Pavement Width	Curb Type Shoulder	On-Street Parking
Minor Internal	20 MPH	Residential Minor	46 Ft.	23 Ft.	City of New Braunfels Standard Curb	One Side Only
Alley or Private Rear Access Drive	15 MPH	Rear Garage Access way or shared drive	20 - 25 Ft.	16 - 20Ft.	Roll Over & City of New Braunfels Standard Curb	None

NOTES:

- 1.) Pavement (asphalt) widths include 24" wide concrete curb and gutter section.
- 2.) Design speed is not the actual speed limit.

Relationship of these PDD standards to other standards and regulations in the City ordinances.
Unless specifically described in these regulations, or further described in the Detailed PDD Plan, the applicable provisions of the City's Zoning and Subdivisions Regulations shall apply to the PDD.